



# PSBEN 5024C/LCD

v.1.1

## PSBEN 27,6V/5A/2x17Ah/EN/LCD Buffer, switch mode power supply unit Grade 3.

EN\*\*

Edition: 9 from 27.11.2019







Supercedes the edition: 8 from 31.01.2019

### LCD Version

# BLACK POWER



## TABLE OF CONTENTS

<b>1. PSU FEATURES.</b>	<b>4</b>
<b>2. FUNCTIONAL REQUIREMENTS OF THE PSU COMPLIANT WITH THE EN 50131-6 STANDARD.</b>	<b>5</b>
<b>3. TECHNICAL DESCRIPTION.</b>	<b>6</b>
3.1 GENERAL DESCRIPTION.	6
3.2 BLOCK DIAGRAM.	7
3.3 DESCRIPTION OF PSU'S COMPONENTS AND CONNECTORS.	8
<b>4. INSTALLATION.</b>	<b>10</b>
4.1 REQUIREMENTS.	10
4.2 INSTALLATION PROCEDURE.	10
<b>5. FUNCTIONS.</b>	<b>12</b>
5.1 CONTROL PANEL.	12
5.2 FIRST RUN OF THE PSU – LANGUAGE SELECTION SCREEN.	12
5.3 MAIN SCREEN OF THE LCD.	13
5.4 INFORMATION DISPLAYED ON THE LCD PANEL.	13
5.4.1 Preview menu.	13
5.4.2 LCD screen – current parameters 	15
5.4.3 LCD screen – current failures 	16
5.4.4 LCD screen – history of the parameters 	16
5.4.5 LCD screen – history of events 	17
5.4.6 List of failure codes and information messages.	18
5.5 ACOUSTIC INDICATION.	20
5.6 TECHNICAL OUTPUTS.	20
5.7 INPUT OF COLLECTIVE FAILURE EXT IN.	21
5.8 ENCLOSURE TAMPER INDICATION - TAMPER.	22
5.9 OVERVOLTAGE PROTECTION OF THE PSU OUTPUT OVP.	22
5.10 PSU OVERLOAD.	22
<b>6. PSU SETTINGS.</b>	<b>23</b>
6.1 PASSWORD.	23
6.1.1 Entering the password.	23
6.1.2 Changing the password.	24
6.1.3 Disabling the password.	24
6.1.4 Resetting passwords.	24
6.1.5 Keyboard lock.	25
6.2 PSU.	26
6.2.1 Setting the battery presence.	26
6.2.2 Battery test ON/OFF.	27
6.2.3 Battery protection ON/OFF.	28
6.2.4 Setting the delay time for EPS output indicating ~230 V power loss.	28
6.2.5 Setting the communication address.  applies to cooperation with PowerSecurity.	29
6.2.6 Setting the transmission parameters.  applies to cooperation with PowerSecurity.	30
6.3 CONTROL PANEL.	31
6.3.1 Setting the display language.	31
6.3.2 Setting the date.	32
6.3.3 Setting the time.	32
6.3.4 Setting the backlight mode.	33
6.3.5 Contrast setting.	33
6.3.6 Blinking light indicating failure.	34
<b>7. RESERVE POWER SUPPLY CIRCUIT.</b>	<b>35</b>
7.1 RUNNING THE PSU FROM THE BATTERY.	35
7.2 DEEP DISCHARGE BATTERY PROTECTION UVP.	35

7.3 BATTERY TEST.....	35
7.4 STANDBY TIME.....	36
7.5 BATTERY CHARGING TIME.....	36
7.6 OPERATION WITHOUT A BATTERY.....	36
<b>8. REMOTE MONITORING (OPTIONS: ETHERNET, RS485).....</b>	<b>37</b>
8.1 ETHERNET NETWORK COMMUNICATION.....	37
8.2 „POWERSECURITY” PROGRAM.....	39
<b>9. TECHNICAL PARAMETERS.....</b>	<b>40</b>
TABLE 16. ELECTRICAL PARAMETERS.....	40
TABLE 17. MECHANICAL PARAMETERS.....	41
TABLE 18. SAFETY OF USE.....	41
<b>10. TECHNICAL INSPECTIONS AND MAINTENANCE.....</b>	<b>42</b>
10.1 BATTERY REPLACEMENT OF THE LCD PANEL.....	42

## 1. PSU features.

- EN50131-6 compliance, 1+3 grades and II environmental class
- mains supply of ~230 V
- uninterrupted voltage of 27,6 V DC
- fitting battery: 2x17 Ah/12 V
- high efficiency 83%
- PSU current efficiency:
  - 1,4 A – for grades 1 , 2 \*
  - 0,56 A – for grades 3 \*\*
  - 5 A – for general use \*\*\*(see: chapter 3.1)
- low level of voltage ripple
- microprocessor-based automation system
- intelligent management of PSU's output power level
- 'SERIAL' communication port with implemented MODBUS RTU protocol
- remote monitoring (option: Ethernet, RS485)
- free program - 'PowerSecurity' for monitoring the PSU operation parameters
- load current control
- output voltage control
- output fuse status control
- dynamic battery test
- battery circuit continuity control
- battery voltages control
- battery fuse status control
- battery charge and maintenance control
- deep discharge battery protection (UVP)
- battery overcharge protection
- battery output protection against short circuit and reverse polarity connection
- jumper selectable battery charging current  
0,6 A/1,5 A/2,2 A/3 A
- remote battery test (additional module required)
- START button for battery activation
- STOP button for disconnecting during battery-assisted operation
- optical indication– LCD panel
  - electrical parameters reading, e.g.: voltage, current
  - failure indication
  - PSU settings adjusted from the panel's level
  - 3 levels of access, password-protected
  - PSU's operation history
  - failure history
  - real-time clock, battery-backed
- optical indication of PSU overload OVL
- acoustic indication of failure
- adjustable times indicating AC power failure
- technical inputs/outputs with galvanic isolation
- EXT IN input of collective failure
- EPS technical output indicating AC power loss
- PSU technical output indicating PSU failure
- APS technical output indicating battery failure
- internal memory of PSU operating status
- protections:
  - SCP short circuit protection
  - OLP overload protection
  - OHP overheat protection
  - OVP over voltage protection
  - surge protection
  - against tampering: unwanted opening of the enclosure or detachment from the mounting surface
- convectional cooling
- warranty – 5 year from the production date

## 2. Functional requirements of the PSU compliant with the EN 50131-6 standard.

Functional requirements	Requirements of EN 50131-6			PSBEN5024C/ LCD
	Grade 1	Grade 2	Grade 3	
EPS network absence	YES	YES	YES	YES
Low battery voltage	YES	YES	YES	YES
Protection against complete battery discharge	-	-	YES	YES
Battery failure	-	-	YES	YES
No battery charge	-	-	YES	YES
Low output voltage	-	-	YES	YES
High output voltage	-	-	YES	YES
PSU failure	-	-	YES	YES
Surge protection	-	-	YES	YES
Short circuit protection	YES	YES	YES	YES
Overload protection	YES	YES	YES	YES
Output fuse activation	-	-	-	YES
Battery fuse failure	-	-	-	YES
EPS technical output	YES	YES	YES	YES
APS technical output	YES	YES	YES	YES
PSU technical output	YES	YES	YES	YES
Input of collective failure	-	-	-	YES
Remote battery test	-	-	-	YES
Tamper indicating enclosure opening	YES	YES	YES	YES
Tamper indicating detachment from the mounting surface	-	-	YES	YES

### 3. Technical description.

#### 3.1 General description.

The buffer power supply is designed in accordance with the requirements of the EN 50131-6 standard, grade 1-3 and II environmental class. It is intended for an uninterrupted supply of alarm system devices requiring stabilized voltage of 24 V DC (+/-15%).

Depending on a required protection level of the alarm system in the installation place, the PSU efficiency and the battery charging current should be set as follows:

\* Grade 1, 2 - standby time 12h

**Output current 1,4 A + 3 A battery charge**

\*\* Grade 3 - standby time 30h if the faults of the main power source are reported to the Alarm Receiving Centre - ARC (in accordance with 9.2 – EN 50131-1 standard).

**Output current 0,56 A + 3 A battery charge**

- standby time 60h if the faults of the main power source are reported to the Alarm Receiving Centre - ARC (in accordance with 9.2 – EN 50131-1 standard).

**Output current 0,28 A + 3 A battery charge**

\*\*\* General use – if the PSU is not mounted in an installation compliant with the EN-50131 standard, the acceptable current efficiency amounts to:

**1. Output current 5 A + 0,6 A battery charge**

**2. Output current 4,1 A + 1,5 A battery charge**

**3. Output current 3,4 A + 2,2 A battery charge**

**4. Output current 2,6 A + 3 A battery charge**

**Total current of the receivers + battery: 5,6 A max.**

In case of power decay, a battery back-up is activated immediately. The PSU is housed in a metal enclosure (color: RAL 9005 - black) with battery space for a 2x17 Ah/12 V battery. It is fitted with micro switches indicating unwanted door opening (front panel) and detachment from the mounting surface.

#### OPTIONAL POWER SUPPLY CONFIGURATIONS:

(visualization available at [www.pulsar.pl](http://www.pulsar.pl))

- 1. Buffer power supply PSBEN 27,6 V/4x1 A/2x17 Ah/INTERFACE**  
- PSBEN 5024C/LCD + LB4 4x1 A (AWZ575, AWZ576)+2x17 Ah+INTERFACE
- 2. Buffer power supply PSBEN 27,6 V/24 V/2,5 A/2x17 Ah/INTERFACE**  
- PSBEN 5024C/LCD + RN25024 (27,6 V/24 V)+2x17 Ah+INTERFACE
- 3. Buffer power supply PSBEN 27,6 V/24 V/4x0,5 A/2x17 Ah**  
- PSBEN 5024C/LCD + RN25024 (27,6 V/24 V)+LB4 4x0,5 A (AWZ575, AWZ576)+2x17 Ah

### 3.2 Block diagram.

The PSU is manufactured based on a high-duty system of DC/DC converter. The microprocessor system is responsible for full diagnostics of the PSU and battery parameters.

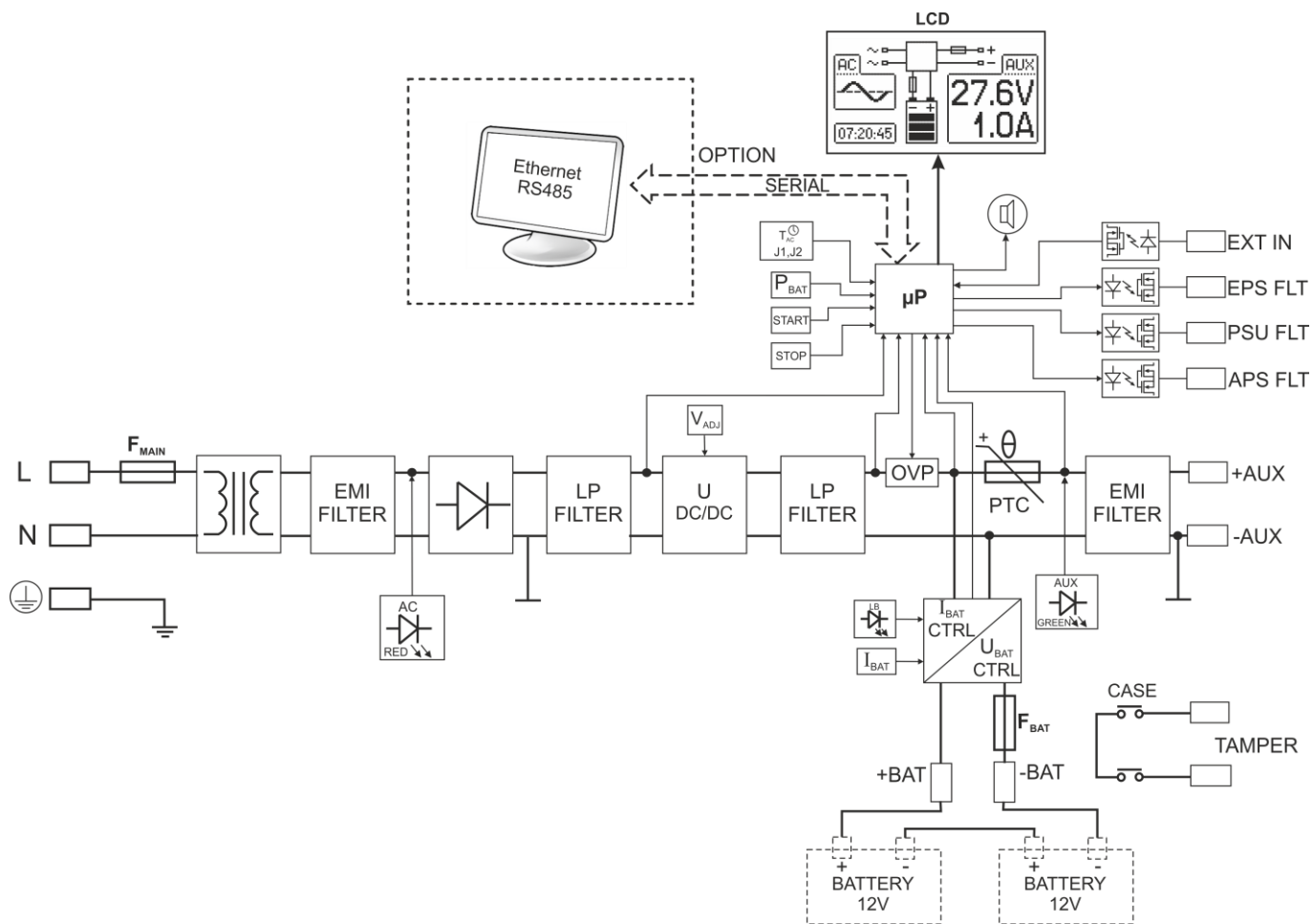



















Fig. 1. Block diagram of the PSU.

### 3.3 Description of PSU's components and connectors.

Table 1. Elements of the PSU pcb (see Fig. 2).

Element no	Description
①	<b>PANEL</b> – optical indication connector
②	<b>P<sub>BAT</sub></b> – jumper; idle in this model <b>T<sub>AC</sub></b> – jumpers J1, J2; idle in this model <i>CAUTION. In this model, jumpers are operated from the LCD desktop's level (see: chapter. 6.2).</i>
③	<b>I<sub>BAT</sub></b> – pin; battery charging current selection J1=  , J2=  J3=  I <sub>BAT</sub> =0,6 A J1=  , J2=  J3=  I <sub>BAT</sub> =1,5 A J1=  , J2=  J3=  I <sub>BAT</sub> =2,2 A J1=  , J2=  J3=  I <sub>BAT</sub> =3 A Caption:  jumper on,  jumper off
④	<b>START</b> – button (launching the PSU from a battery) <b>STOP</b> – button (disconnection of the PSU during battery-assisted operation)
⑤	*) – pin; activation of the acoustic indication  - indication on  - indication off Caption:  jumper on,  jumper off
⑥	<b>V<sub>ADJ</sub></b> – potentiometer, DC voltage adjustment
⑦	<b>BUZZER</b> – acoustic indicator
⑧	<b>F<sub>BAT</sub></b> – fuse in the battery circuit
⑨	<b>Connectors:</b> <b>~AC~</b> – AC power input <b>+BAT</b> – DC power battery output <b>+AUX</b> – DC power output (+AUX= +U, -AUX=GND) <b>EPS FLT</b> – technical output of AC network absence indication open = AC power failure close = AC power - O.K. <b>PSU FLT</b> – technical output of PSU failure open = failure close = PSU working correctly - O.K. <b>APS FLT</b> – technical output of battery failure open = battery failure close = battery O.K. <b>EXT IN</b> – input of collective failure
⑩	<b>V<sub>EXT</sub> pin</b> – polarization of EXT IN circuit
⑪	<b>Communication connector</b>
⑫	<b>LEDs – optical indication:</b> <b>AC</b> – presence of the AC power <b>AUX</b> – DC output voltage <b>OVL</b> – PSU overload <b>PSU</b> – PSU failure <b>APS</b> – battery failure <b>EXT</b> – EXT IN input's status <b>LB</b> – battery charge
⑬	<b>OVP</b> – optical indication for activating the over voltage system
⑭	<b>TAMPER</b> – connector for the micro switch tamper



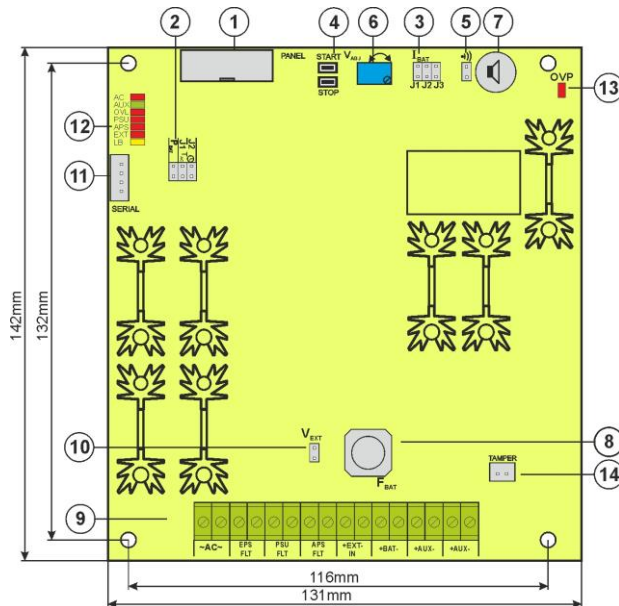

Fig. 2. The view of the PSU's PCB.

Table 2. PSU elements (see fig. 3).

Element no.	Description
①	Insolation transformer
②	PSU board (see Tab.1, fig.2)
③	<b>TAMPER</b> ; micro-switch (contacts) of tamper resistance ( <b>NC</b> )
④	<b>F<sub>MAINS</sub></b> fuse in the supply circuit (~230 V)
⑤	<b>L-N</b> power supply connector ~230 V,  protective connector
⑥	Battery connectors: positive: +BAT = red, negative: - BAT = black
⑦	Tamper grip



Fig.3. The view of the PSU.

## 4. Installation.

### 4.1 Requirements.

The PSU is to be mounted by a qualified installer, holding relevant permits and licenses (applicable and required for a given country) for ~230 V in and low-voltage installations.

As the power supply is designed for a continuous operation and is not equipped with a power-switch, therefore, an appropriate overload protection in the power supply circuit should be provided. Moreover, the user should be informed how to disconnect the power supply unit from the mains supply (usually by assigning an appropriate fuse in the fuse box). The electrical system shall be made in accordance with applicable standards and regulations. The power supply should operate in a vertical position in order to provide free and convectional air flow through ventilating holes of the casing.



The PSU is protected against access to the configuration menu through two-level passwords. If the default settings should be changed, unlock access by entering the service password – see Table 4 and section 6.1.

### 4.2 Installation procedure.



#### CAUTION!

Before installation, cut off the voltage in the ~230 V power-supply circuit.

To switch off power use an external switch in which the distance between the contacts of all poles in the disconnection state is not less than 3mm.

It is required to install an installation switch with a nominal current of min. 3 A in the power supply circuits outside the power supply unit.

1. Mount the PSU in a selected location. It is particularly important to bolt the tamper grip to the mounting surface. The grip is located in the central part of the enclosure (see fig. 3 [7]) and guarantees indication in case of any attempts of detaching the device from the mounting surface. Proper installation is one of the requirements of the EN 50131-6 standard.

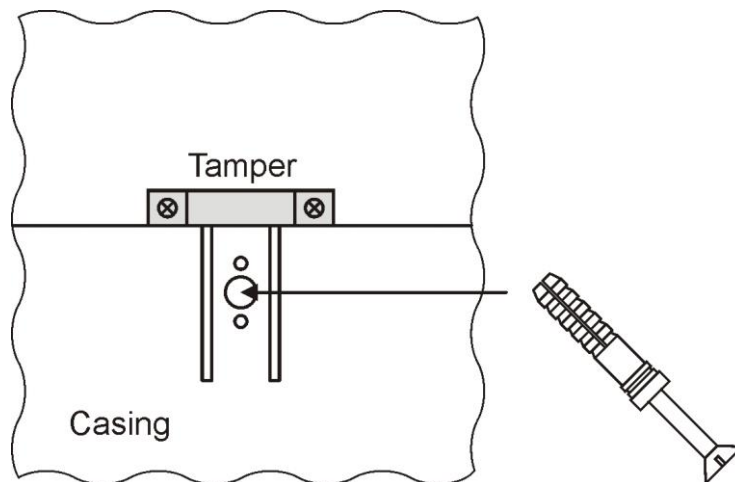



Fig. 4. Fixing a tamper grip.

2. Connect the power cables (~230 V) to L-N terminals of the PSU. Connect the ground wire to the terminal marked by the earth symbol: . Use a three-core cable (with a yellow and green protection wire) to make the connection. Lead the cables to the appropriate terminals through the insulating bushing.



The shock protection circuit shall be performed with a particular care, i.e. the yellow and green wire coat of the power cable shall stick to one side of the terminal - marked with the grounding symbol  on the PSU enclosure. Operation of the PSU without the properly made and fully operational shock protection circuit is UNACCEPTABLE! It can cause a device failure or an electric shock.

3. Connect the receivers' cables to the +AUX, -AUX connectors of the terminal block on the PSU board.

4. If necessary, connect the device's leads to the technical inputs and outputs:

- EPS FLT; technical output of AC power loss indication (alarm panel, controller, indicator, etc.)
- PSU FLT; technical output of the PSU failure.

- APS FLT; technical output of the battery failure.
  - TAMPER; output indicating enclosure opening or detachment from the assembly surface.
  - EXT IN; input of collective failure.
5. With the  $I_{BAT}$  jumper determine the maximum battery charging current, in accordance with the battery parameters.
  6. With the  $P_{BAT}$  jumper determine if the discharged battery disconnection system  $U < 20\text{ V}$  (+/-5%) shall be on or off. **The battery protection is on when the  $P_{BAT}$  jumper is off.**
  7. Switch on the ~230 V supply (red AC diode and green AUX diode should be on).
  8. Check the output voltage (the PSU voltage without load and without battery should amount to 27,5 V±27,7 V, with a battery or during battery charging process: 22 V±27,6 V). If the value of the voltage requires adjustment, it should be set with use of the  $V_{ADJ}$  potentiometer, monitoring the voltage at the AUX output of the PSU.
  9. Connect the batteries in accordance with the markings: +BAT red to 'plus', -BAT black to 'minus'. The LB diode should be on during battery charging process.
  10. Press the STOP button to activate or deactivate a dynamic battery test. Deactivating the test turns out the PSU failure indication at the APS FLT output, but it does not affect the protection system against complete battery discharge.
  11. Check the current consumption of the receivers, taking into account the battery charging current, so as not to exceed the total current efficiency of the PSU.
  12. Once the tests are completed, close the PSU cover.

**Table 3. Operation parameters.**

Environmental class	II
Operating temperature	-10°C...+40°C
Storing temperature	-20°C...+60°C
Relative humidity	20%...90%, no condensation
Sinusoidal vibrations during operation	EN 50130-5
Surges during operation	EN 50130-5
Direct insolation	unacceptable
Vibrations and surges during transport	PN-83/T-42106

**Table 4. Factory settings of the PSU.**

Indication time of EPS network loss	5s	section 5.6
Battery charging current	1,5 A	section 7.5
Battery presence	YES (battery present)	section 7.6
Battery test	ON	section 6.2.2 section 7.3
Deep discharge battery protection UVP	ON	section 7.2
Acoustic indication	ON	section 5.5
Communication address	1	section 6.2.5
Transmission	115.2k 8E1	section 6.2.6
Highlighting	Constant – 50%	section 6.3.4
Blinking light indicating failure	ON	section 6.3.6
Passwords:		
- user's	1111	section 6.1
- installer's	1234	
- keyboard lock	NO	

## 5. Functions.

### 5.1 Control Panel.

The PSU features a panel with buttons and LCD display, enabling reading of all the available electrical parameters. The panel buttons are used to select and confirm the parameters, which should be displayed.

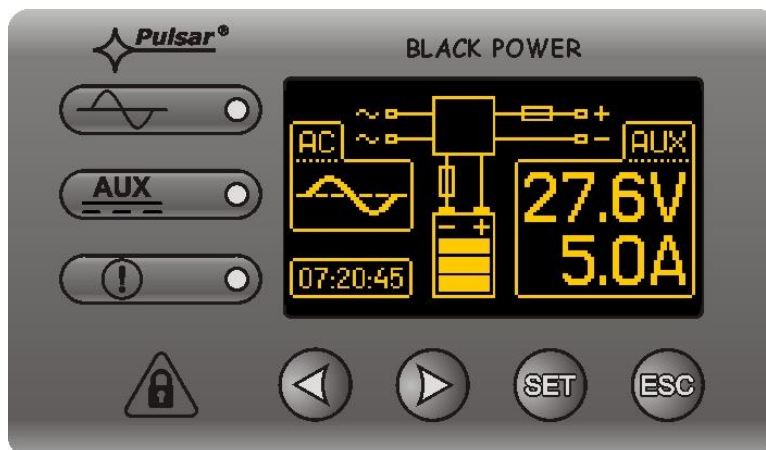

Fig. 5. Control panel.

Table 5. The description of the buttons and LEDs of the LCD panel.

	- move the cursor on the display - next screen selection
	- selection approval
	- leaving the editing mode without changing the values - entering the overview menu mode
	- red LED indicating the presence of ~230 V voltage
	- green LED indicating power at the AUX output of the PSU
	- red LED indicating the PSU failure

### 5.2 First run of the PSU – language selection screen.

During the first run of the PSU, language selection screen will be displayed. Use the „<” or „>” buttons to select the available languages. After selecting the appropriate language, confirm by pressing the "SET" button. The main screen will be displayed.



Fig. 6. Language selection screen.

If the language selection is not done, language selection screen will be displayed on the next startup. If the choice has already been made, language selection can be done as explained in section 6.3.1.

### 5.3 Main screen of the LCD.

Main screen of the LCD displays the basic electrical parameters and indicates the current status of the power supply.

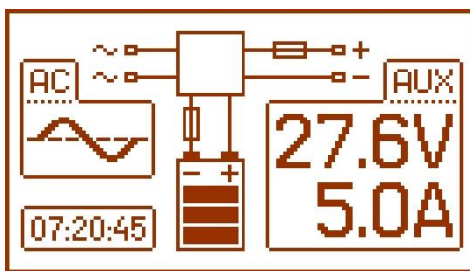









Fig. 7. Main screen of the LCD.



The resolution of voltage and current measurement is 0.1 V and 0.1 A, respectively. The displayed values of voltages and currents should be treated with caution; if a greater accuracy is required, use a multimeter.

Table 6. The description of the main screen symbols.

Screen field	Operating status	Failure status
 		Blinking „FAIL” message
	Information about the current voltage and power consumption at the AUX output.	The parameter, which value has been exceeded, is blinking.
	Information about the current state of battery charge	Blinking icon.
		The blinking warning symbol is displayed.
		Fuse icon - blinking.
	Clock	

### 5.4 Information displayed on the LCD panel.

#### 5.4.1 Preview menu.

Pressing the „ESC” button at the bottom of the display starts the preview menu, allowing to choose one of the four available PSU screens.

Use the „<” or „>” buttons to choose a proper screen and press the „SET” button to confirm.



- current parameters of the PSU





- current failures of the PSU  
(see section 5.4.3)



- parameters of the PSU stored in the memory  
(see section 5.4.4)

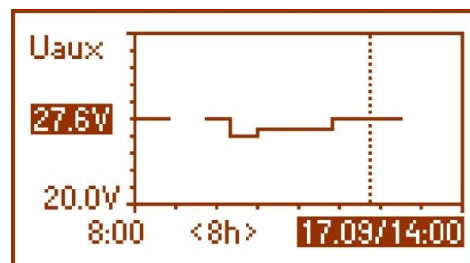

- History of events  
(see section 5.4.5)

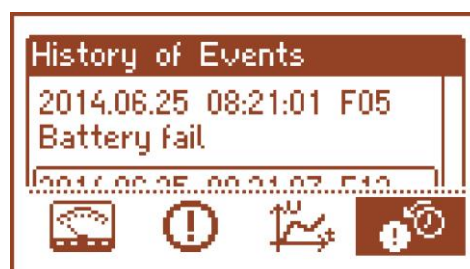

5.4.2 LCD screen – current parameters 











To set the screen, press the „ESC” button, use the „<” or „>” buttons to choose the  icon and press the „SET” button to confirm.

The screen displays electrical parameters and the status of the technical outputs during operation. Illumination of an element informs about an activation and reflects the status of LEDs on the PCB of the PSU (see Table1, [12]).



Fig. 8. LCD panel – PSU parameters.

Table 7. The description of the screen symbols - current parameters of the PSU.

Screen field	Description	Additional information
	~230 V power ON (highlighted = AC power on)	Sections 6.2.4
	- Battery charging indication (highlighted = battery charging)	
	- PSU overload indication (highlighted = PSU overload)	Sections 5.10
	- PSU failure indication (highlighted = PSU failure)	Sections: - 5.4.6 - 5.6
	- Battery failure indication (highlighted = battery failure)	Sections: - 5.4.6 - 5.6
	- EXTi input status indication (highlighted = EXTi input activated)	Sections: - 5.4.6 - 5.7
	The current settings of the P <sub>BAT</sub> , J1 and J2 jumpers.	
	TAMPER input status (highlighted = activated)	Sections 5.8
	Current electrical parameters of the PSU: $U_{BAT}$ – battery voltage $U_{AUX}$ – AUX output voltage $I_{AUX}$ – output current	Sections 5.4.4
	The status of the technical outputs: <b>EPS</b> - AC power indication open= AC power failure closed = AC power – O.K. <b>PSU</b> – PSU failure indication open= PSU failure closed = PSU working correctly O.K. <b>APS</b> – battery failure indication open= battery failure closed = battery O.K.	Sections: 5.4.6 5.6

### 5.4.3 LCD screen – current failures

In case of abnormal electrical parameters during the operation, the PSU will indicate a failure by displaying a message on the LCD, turning on the red LED  on the panel, activating acoustic indication (if enabled) and changing the status of a dedicated technical output.



Fig. 9. Message indicating blown fuse at the AUX output.

At a given time, multiple failures can occur. To check which faults are indicated, choose the current failures of the PSU screen.

To do that, press the „ESC” button, use the „<” or „>” buttons to choose the  icon and press the „SET” button to confirm.



Fig. 10. LCD screen – current failures of the PSU.

The screen displays the codes and descriptions of failures. The display order of failures is arranged by priority of importance. The first failures in the display order are of the highest priority.

If there are more than five failures at the same time, use the „<” or „>” buttons to display the next failure..

### 5.4.4 LCD screen – history of the parameters

To set the screen, press the „ESC” button, use the „<” or „>” buttons to choose the  icon and press the „SET” button to confirm.

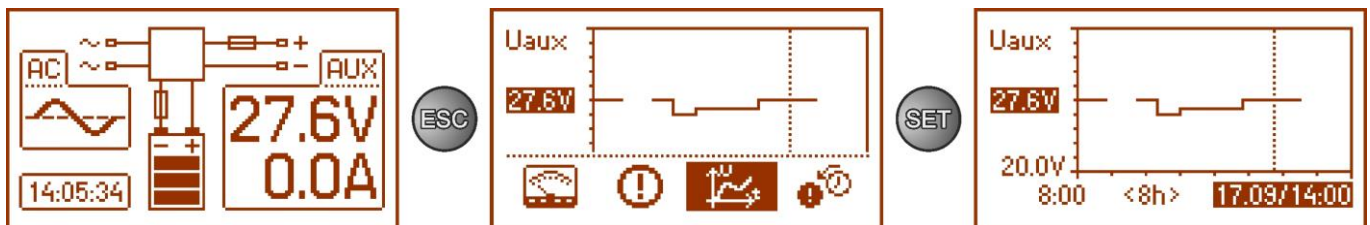

Fig. 11. Screen of the history of PSU’s parameters.

During normal operation, the PSU records voltage and current parameters at the output circuits and saves them in the internal non-volatile memory. The saving is repeated in 5 minutes intervals and the internal memory can store up to about 6144 values. The memory works in a circular cycle - when the memory is full, the oldest entries are replaced with the newest ones.

The screen of the parameters history enables reading of the stored parameters and scanning the values on a chart. The screen features a time axis, located horizontally in the bottom part of the chart, and a parameter axis, located vertically in the left. Use the „<” or „>” buttons to move the cursor into various time points and read the value of the measurement.



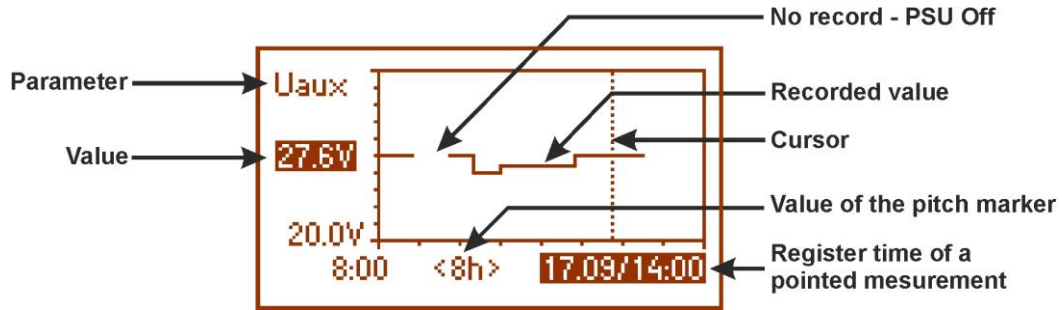

Fig. 12. Screen of the history of PSU's parameters.

In order to change the displayed parameter, highlight its name by pressing the „SET” button and use the „<” or „>” buttons to choose the requested parameter. Pressing the „SET” button again will highlight the time range of the chart, which also can be changed with the „<” or „>” buttons. Pressing the „SET” button again will enable moving the cursor (vertical dotted line on the chart) along the time line with the „<” or „>” buttons. The values of current parameter and the recording time pointed by the cursor will also be highlighted.

Among the available positions on the chart, it is possible to view the following values:

- current - the value measured at the end of the measuring cycle
  - minimum - the lowest value measured during 5 minutes
  - maximum - the highest value measured during 5 minutes
- of the following parameters:

- $U_{AUX}$  - AUX output voltage
- $U_{AUX\ MIN}$  - AUX output voltage - minimum
- $U_{AUX\ MAX}$  - AUX output voltage - maximum
  
- $I_{AUX}$  - output current
- $I_{AUX\ MIN}$  - output current, minimum
- $I_{AUX\ MAX}$  - output current, maximum

To optimally read and analyze the values shown in the chart, it is possible to change the time range on the bottom axis of the chart. The following ranges are available:

- <8h>
- <24h>
- <2days>
- <week> (weekly)

### 5.4.5 LCD screen – history of events

In case of abnormal electrical parameters during the operation, the PSU will indicate a failure by displaying a message on the LCD, periodically turning on and off the LCD backlight, turning on the red LED ALARM on the panel, activating acoustic indication (if enabled) and changing the status of a dedicated technical outputs.

To choose the history of events screen, press the „ESC” button, use the „<” or „>” buttons to choose the icon and press the „SET” button to confirm.

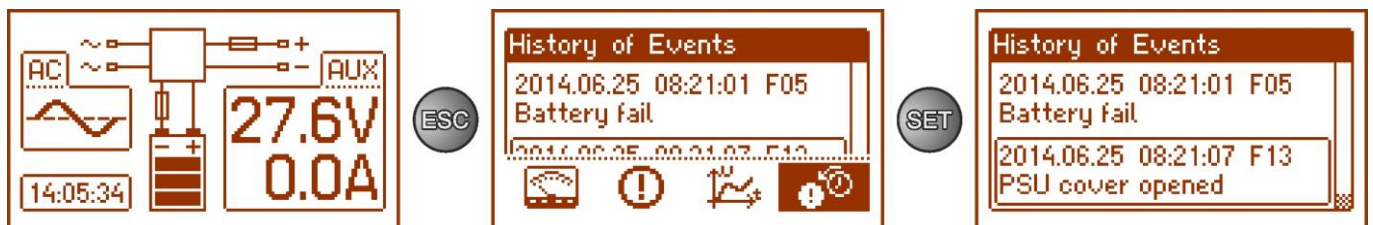

Fig. 13. The history of events screen.

The history of events screen enables overviewing the events recorded by the internal diagnostic system. The internal memory can store up to 2048 events, carrying information about the fault type, time of occurrence and the values of other electrical parameters. In addition, the diagnostic system assigns the failure code for a particular event on the basis of the stored parameters.

In order to preview the history of events, use the „<” or „>” buttons. It can be done in two modes: short mode(date, time, code, fault description) or full mode - with additional information about electrical parameters and status of inputs and outputs. To switch between the modes, press the „SET” button.

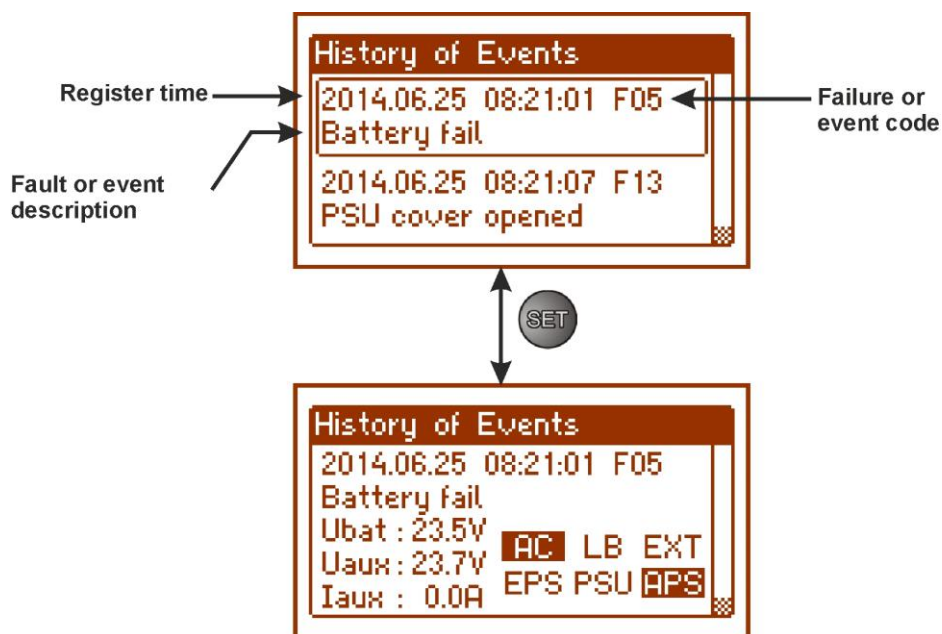

Fig. 14. Description of the history of events screen.

Section 5.4.6 lists all codes that may occur during the operation of the PSU. The individual codes are accompanied by appropriate optical indication on the panel, acoustic indication and activation of a dedicated technical output.



The memory of the new power supply remembers the events that are the result of the efficiency tests carried out at the production stage.

**5.4.6 List of failure codes and information messages.**

The PSU indicates the operation status with the appropriate code. The codes are divided into two groups, marked with the initial letters "F" or "I".

The codes beginning with the letter "F" indicate a failure. The codes that begin with the letter "I" indicate the correct operation of the PSU or repaired fault, involving, for example, fuse replacement: "I03 - BAT fuse replaced".

**Table 8. List of PSU failure codes.**

Failure code	Information	Technical output activation	Additional information	Additional information
F01	AC power fail!	EPS FLT	- No AC mains supply - F <sub>MAINS</sub> fuse failure	
F02	AUX fuse fail!	PSU FLT	- Blown F <sub>AUX</sub> fuse - AUX output overload	
F03	BAT fuse fail!	APS FLT	- Blown F <sub>BAT</sub> fuse - Short circuit in the battery circuit - Short circuit in the AUX output circuit	
F04	Output overload!	PSU FLT	- PSU overload	Section 5.10
F05	Battery fail!	APS FLT	- Worn out battery - Undercharged battery - Battery not connected	Section 5.6 Section 7
F06	High AUX voltage!	PSU FLT	- Output voltage over 29.4 V	
F07	High battery voltage!	PSU FLT	- Battery voltage >28 V	
F08	Charge circuit fail!	PSU FLT	- The output voltage of the PSU set too low, below 26 V - Battery charging circuit failure	
F09	Low AUX voltage!	PSU FLT	- Output voltage below 23,6 V (during buffer operation)	
F10	Low battery voltage!	APS FLT	- the battery voltage has dropped below 23 V	

			(during battery-assisted operation)	
<b>F11</b>	Low battery volt. – off!	APS FLT	- the battery voltage has dropped below 20 V (during battery-assisted operation)	
<b>F12</b>	External input EXTi!		- Activation of the input of collective failure EXT IN	Section 5.7
<b>F13</b>	PSU cover opened!	PSU FLT		
<b>F50-F54</b>	Internal supply fail!	PSU FLT	- service codes	
<b>F60</b>	No communication	PSU FLT	- no communication with LCD panel	
<b>F61-F64</b>	Control panel fail	PSU FLT	- service codes	
<b>F65</b>	Access unlocked		- passwords unlocked	

Table 9. List of PSU message codes.

Message code	Description
<b>I00</b>	Power supply start-up
<b>I01</b>	AC power back
<b>I02</b>	AUX fuse replaced
<b>I03</b>	BAT fuse replaced
<b>I04</b>	Battery OK
<b>I05</b>	Battery test – START
<b>I06</b>	PSU cover closed

Table 10. Optical indication of failure with the PSU LED on the PCB of the PSU.

The number of flashes of the PSU LED on the PCB of the power supply	Failure code	Failure description
<b>1</b>	F06	High AUX voltage!
<b>2</b>	F07	High battery voltage!
<b>3</b>	F08	Charge circuit fail!
<b>4</b>	F09	Low AUX voltage!
<b>5</b>	F50-F54 F60	Internal supply fail! No communication
<b>6</b>	F13	PSU cover opened!

### 5.5 Acoustic indication.

Emergency situations are acoustically indicated. The frequency and the number of signals depend on an event type (see chapter. 5.4.6). The acoustic indication is off after removing an appropriate jumper (fig. 2, [5]).

Table 11. Acoustic indication.

No.	Description	Event
1	1 signal per 10s, battery-assisted operation	No ~230 V supply
2	1 signal per 10s, mains operation	Battery fault, undercharged battery
3	2 signals per 10s, battery-assisted operation	Low level of battery charge
4	Fast signals, battery-assisted operation	The PSU will be disconnected due to the battery discharge
5	Continuous indication	PSU failure [see chapter. 5.4.6]
6	1 signal	Breaking the battery test
7	2 signals	Activation of the battery test

### 5.6 Technical outputs.

The PSU feature indication outputs, with galvanic isolation, which change their state if any of the following events occur:

- EPS FLT - output indicating 230 V power loss.**  
 The output indicates 230 V power loss. Under normal status, with the 230 V power on, the output is closed. In case of power failure, the PSU will switch the output into the open position after a time lag determined in the „ Delay time for EPS output” menu (see section. 6.2.4).
- APS FLT - output indicating battery failure.**  
 The output indicates a failure in the battery circuit. Under normal status (during correct operation) the output is close. In case of a failure the PSU will switch the output into the open state. Any failures can be triggered by the following events:
  - a faulty or undercharged battery
  - battery voltage below 23 V during battery-assisted operation
  - battery fuse failure
  - no continuity in the battery circuit
- PSU FLT - output indicating PSU failure.**  
 The output indicates the PSU failure. Under normal status (during correct operation) the output is close. In case of a failure the PSU will switch the output into the open state. Any failures can be triggered by the following events:
  - low output voltage  $U_{aux} < 23,6\text{ V}$
  - high output voltage  $U_{aux} > 29,4\text{ V}$
  - high battery voltage  $U_{aku} > 28\text{ V}$  (during battery test)
  - polymer fuse PTC activation
  - exceeding the PSU nominal current
  - failure in the battery charging circuit
  - activation of the over voltage protection OVP
  - enclosure opening - TAMPER
  - internal damage of the PSU
  - EXT IN input activation

The technical outputs have been implemented with galvanic isolation between the PSU’s systems and the attached devices.

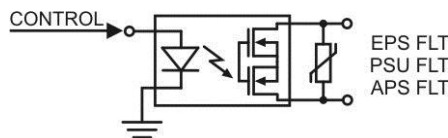

Fig. 15. Electrical diagram of the technical outputs.

### 5.7 Input of collective failure EXT IN.

The EXT IN (external input) technical input indicating a collective failure is intended for additional, external devices that generate the failure signal. The voltage at the EXT IN input will save information about an incident in the internal memory of the power supply and sending the signal about the failure to the PSU FLT output.

The EXT IN technical input has been implemented with galvanic isolation between the PSU's systems and the devices attached.

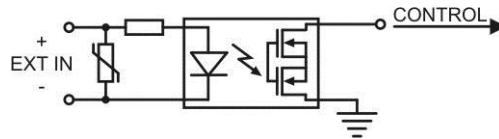

Fig. 16. Electrical diagram of the EXT IN input.

The electrical diagram below shows the way of connecting external devices to the EXT IN input. Outputs such as: OC (open collector), relay may be used as a source of the signal.

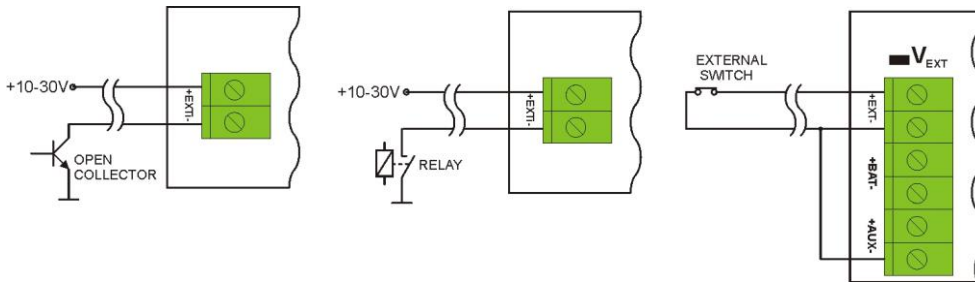

Fig. 17. Examples of connections.

In the option with tamper switches, the  $V_{EXT}$  jumper must be on. It polarizes the EXT IN input circuit therefore is required in such configuration.

The EXT IN input has been adjusted to cooperate with fuse modules that generate a failure signal in case of a fuse fault in any of output sections (e.g. AWZ535, AWZ536). To guarantee a correct cooperation between the module and the EXT IN input, the  $V_{EXT}$  jumper must be on and the connections are to be made accordingly to the diagram below.

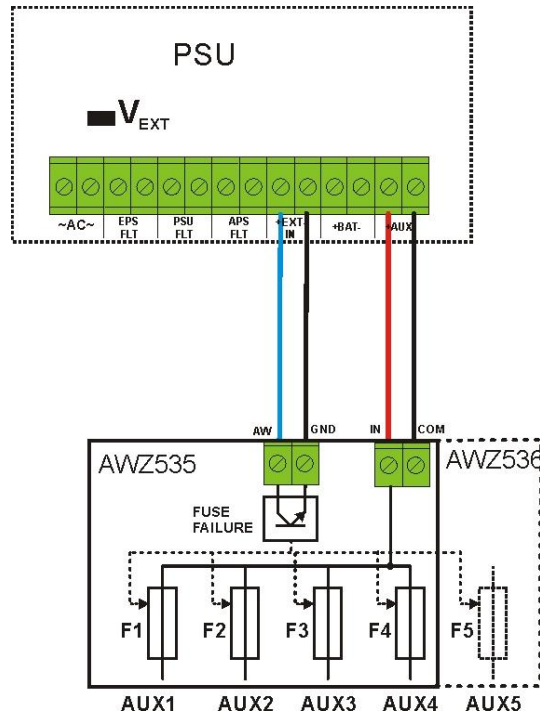

Fig. 18. Example of a connection with the fuse module: AWZ535 or AWZ536.

### **5.8 Enclosure Tamper Indication - TAMPER.**

The PSU is fitted with the micro switch tamper indicating enclosure opening and detaching from the mounting surface.

The tamper cable is not connected to the terminal in the factory settings. In order to activate tamper, remove the jumper from tamper terminal (Fig. 2 [14]) and plug in the tamper cable.

Each opening the enclosure and detaching from the mounting surface will generate a failure signal at the PSU FLT and ALARM technical outputs and will save the event in the internal memory of the PSU.

### **5.9 Overvoltage protection of the PSU output OVP.**

In case of voltage exceeding  $15,5 \text{ V} \pm 0,5 \text{ V}$  at the switching regulator's output, the system cuts off the power at the outputs to protect the battery and the receivers from damage. The outputs will be battery-powered. The activation of the protection system is indicated by the OVP yellow LED on the PCB board, and the PSU FLT output.

### **5.10 PSU overload.**

The PSU is fitted with the LED OVL (overload) on the PCB informing about output overload. If the nominal current of the PSU is exceeded, the led turns on and the microprocessor starts a specially implemented procedure. Depending on time and overload level, microprocessor may disconnect the AUX output and switch into the battery-assisted operation. Restart will occur after 1 minute.

PSU overload is indicated by the PSU FLT technical output.

### 6. PSU settings.

The PSU has a configuration menu, allowing to configure the PSU settings by changing or activating certain parameters. To enter the setting mode, press the "SET" button from the main screen's level.

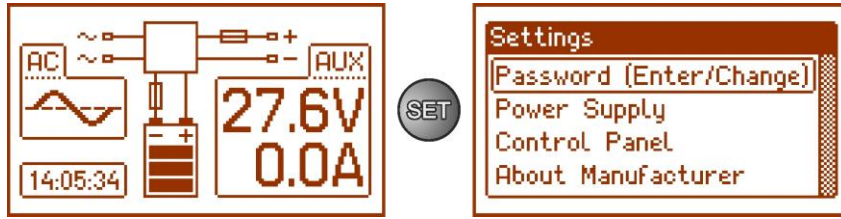

Fig. 19. PSU settings screen.

#### 6.1 Password.

The PSU supports two levels of access to configuration, which limit the possibility of changing the PSU's settings from the LCD panel. Both levels are protected by a separate password.

- Service password** – full access to the PSU's settings
- User's password** – locked access to the „PSU” settings menu

Table 12. Access ranges.

PASSWORD	Access range	
	„Control panel” settings	PSU settings
SERVICE	•	•
USER	•	-



- Preset passwords:
- user's password – 1111
  - service password – 1234

#### 6.1.1 Entering the password.

If the access to the configuration of the power supply has been blocked by the activation of the service or user password, perform the following steps in order to unlock the PSU configuration:

- use the „<” or „>” buttons to display the **Password (enter/change)** menu
- press the „SET” button, another window with available levels of passwords will be displayed
- use the „<” or „>” buttons to choose the right level of password

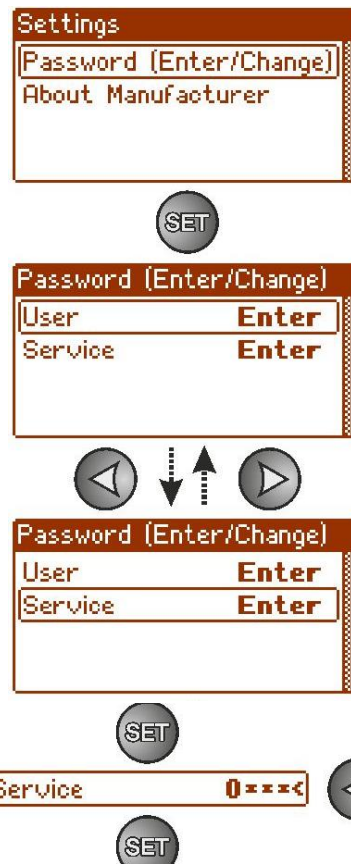

- confirm by pressing the "SET" button
- use the „<” or „>” buttons to enter the first digit
- confirm by pressing the "SET" button
- use the „<” or „>” buttons to enter the second digit
- confirm by pressing the "SET" button
- use the „<” or „>” buttons to enter the third digit
- confirm by pressing the "SET" button
- use the „<” or „>” buttons to enter the fourth digit
- confirm by pressing the "SET" button

If the entered password is wrong, the following message will be displayed:



Fig. 20. The message after entering a wrong password.

After entering the correct password, it is possible to access the settings. If no buttons are pressed within 5 minutes, the PSU settings will be locked automatically.

#### 6.1.2 Changing the password.

After entering the correct password, it is possible to change it. To do this, choose a password that will be changed (user's password or service password) and enter the new one.

#### 6.1.3 Disabling the password.

If the password is not required, it can be turned off. The access to the settings will not be locked after 5 minutes of inactivity.

To disable the password, type „0000” as a new password.

User password „0000” unlocks the access from the user level.

Service password „0000” unlocks the access from the installer level.

#### 6.1.4 Resetting passwords.

If, for any reason, the passwords have been lost, it is possible to reset the passwords.

To do this:

- a) unplug the PSU from the AC network and the batteries for at least 10 seconds
- b) Press the STOP button on the printed circuit board of the power supply
- c) Connect the battery and turn on the AC mains still holding down the button for another 10 seconds
- d) The PSU will display a message: „**Access unlocked**”,
- e) Confirm by pressing the „SET” button
- f) Go to the menu „**Settings -> Password**” and change the passwords.



6.1.5 Keyboard lock.

When entering passwords, it is possible to choose whether the buttons on the front panel of the PSU's should be locked. It is enabled by „Keyboard password” option.

- use the „<” or „>” buttons to display the **Keyboard lock** menu



- press the „SET” button, the prompt will appear at the end of the line



- use the „<” or „>” buttons to select:  
**YES** – keyboard lock ON  
**NO** – keyboard lock OFF



- confirm by pressing the "SET" button



When on, the keyboard will be locked automatically if no buttons are pressed within 5 minutes. After this time, pressing any button on the control panel will display a window with keyboard password request. Enter the password using the „<” or „>” buttons as explained above.



Fig. 21. Keyboard password request.

Entering the correct user’s password unlocks the access to the settings from the user level, while entering the correct service password unlocks the access to the settings from the installer level – full access.



The PSU settings will be locked automatically if no buttons are pressed within 5 minutes.

### 6.2 PSU.



The "PSU" menu is only available after entering the correct service password.

Selecting the "PSU" in the settings menu will display another menu, allowing full configuration of the PSU; battery test ON/OFF, acoustic indication ON/OFF, EXTto output ON/OFF, setting the delay time for EPS output, setting the communication parameters. After entering the right settings, they are stored in the internal non-volatile memory, which protects the PSU against data loss in case of a failure or power failure.

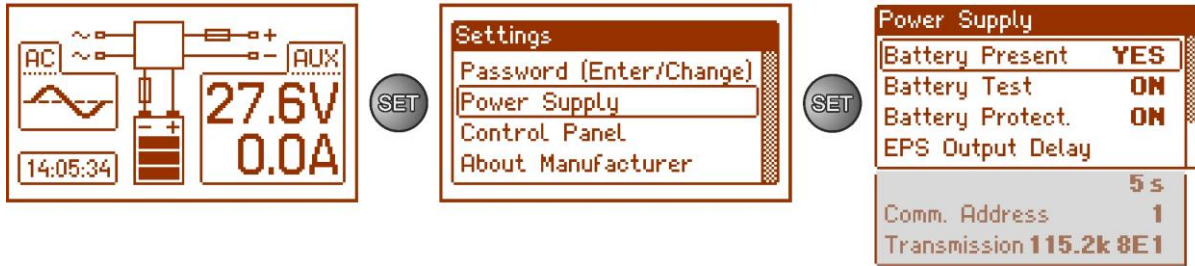

Fig. 22. „PSU” screen.

Table 13. The description of the „PSU” screen.

Position	Description	Additional information
<b>Battery ON</b>	<b>YES</b> – battery connected to the power supply <b>NO</b> – battery not connected to the power supply	(see section. 7.6)
<b>Battery test</b>	<b>ON</b> – battery test ON <b>OFF</b> – battery test OFF	Section 6.2.2 and 7.3
<b>Battery protection</b>	<b>ON</b> – battery protection (disconnection) ON <b>OFF</b> – battery protection (disconnection) OFF	Section 6.2.3
<b>Delay time for EPS output</b>	Setting the delay time for AC power failure indication: <b>5s/2min 20s/17min/2h20min</b>	Section 6.2.4
<b>Communication address</b>	<b>1÷ 247</b> PSU address required during the communication with the computer <b>1</b> – factory setting	Section 6.2.5
<b>Transmission</b>	Defines the speed and protocol of communication <b>9.6k 8N2</b> <b>9.6k 8E1</b> <b>9.6k 8O1</b> : <b>115.2k 8N2</b> <b>115.2k 8E1</b> (factory setting) <b>115.2k 8O1</b>	Section 6.2.6

#### 6.2.1 Setting the battery presence.

The PSU can operate without a battery. In this mode, the automation system allows for adjustment of the PSU output voltage without signaling the battery failure.



CAUTION. When operating without a battery, the power supply does not control the parameters associated with its functioning properly and therefore this mode should be chosen consciously.



- use the „>” or „<” buttons to display the **Battery present** menu



- press the „SET” button, the prompt will appear at the end of the line
- use the „<” or „>” buttons to select
  - YES** – if the battery is connected to the power supply
  - NO** – if the battery is not connected to the power supply
- confirm by pressing the „SET” button

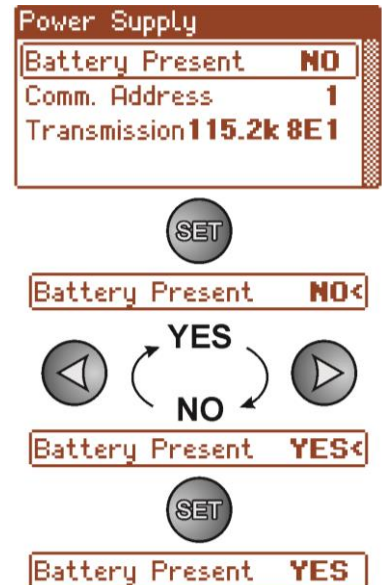

**6.2.2 Battery test ON/OFF.**

This function allows to enable or disable the battery test (see section 7.3) during which the power supply measures the electrical parameters in accordance with the implemented measurement procedure.

- use the „<” or „>” buttons to display the **Battery test** menu



- press the „SET” button, the prompt will appear at the end of the line
- use the „<” or „>” buttons to select
  - ON** – battery test ON
  - OFF** – battery test OFF

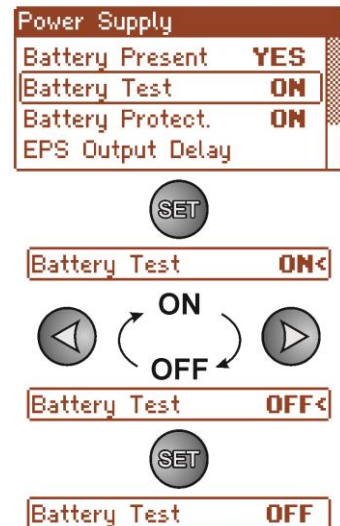

- confirm by pressing the „SET” button

**Enabling/disabling the battery test using the STOP button on the printed circuit board of the power supply.**

Press and hold the STOP button on the printed circuit board for 3 seconds during mains operation of the PSU. The device will confirm the activation or deactivation of the test:

- Single beep
- Double beep



Enabling/disabling the battery test is stored is stored even after the device is disconnected from the power supply. Disabling the test also disables the battery failure indication at the APS FLT output but does not disable the deep discharge battery protection.

**6.2.3 Battery protection ON/OFF.**

This function enables or disables the battery protection against excessive discharge UVP (see section 7.2).

- use the „>” or „<” buttons to display the **Battery protect.** menu



- press the „SET” button, the prompt will appear at the end of the line

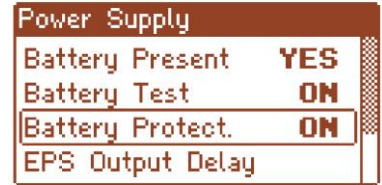

- use the „<” or „>” buttons to choose  
**ON** – battery protection (disconnection) ON  
**OFF** – battery protection (disconnection) OFF



- confirm by pressing the „SET” button



**6.2.4 Setting the delay time for EPS output indicating ~230 V power loss.**

The PSU features adjustable delay for 230 V power loss indication. The delay time can be selected from the four available ranges:

- 5s (factory setting)
- 2min 20s
- 17min
- 2h 20min

230 V power loss is indicated by the activation of the “EPS FLT” technical output.

- use the „<” or „>” buttons to display the Delay **time for EPS output** menu

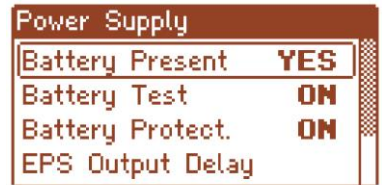

- press the „SET” button, the prompt will appear at the end of the line



- use the „<” or „>” buttons to set the delay time:
  - 5s
  - 2min 20s
  - 17min
  - 2h 20min

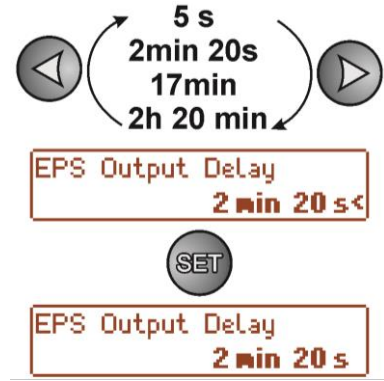

- confirm by pressing the „SET” button

**6.2.5 Setting the communication address.**  applies to cooperation with PowerSecurity.

 All power supplies are factory-set to address 1.

All the parameters responsible for communication between the PSU and the computer, namely the address, parity and speed should have the same settings for both the PSU and the PowerSecurity program. Communication address allows to identify power supply units in the same communication network.

- use the „<” or „>” buttons to display the **Communication address** menu

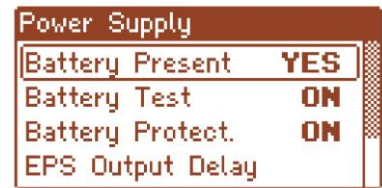

- press the „SET” button, the prompt will appear at the end of the line



- use the „<” or „>” buttons to set the communication address  
**1 ÷ 247** – PSU address during the communication with the computer



- confirm by pressing the „SET” button



### 6.2.6 Setting the transmission parameters. applies to cooperation with PowerSecurity.

All the parameters responsible for communication between the PSU and the computer, namely the address, parity and speed should have the same settings for both the PSU and the PowerSecurity program.

The PSU has preset transmission parameters of 115200 baud 8E1; if these values were changed, they should be restored to original settings.

- use the „<” or „>” buttons to display the **Transmission** menu

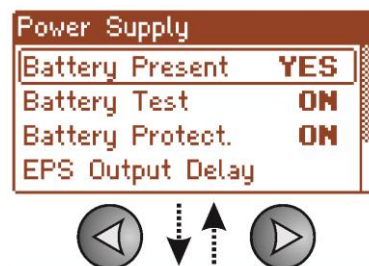

- press the „SET” button, the prompt will appear at the end of the line

- use the „<” or „>” buttons to set the transmission speed

- 9.6k 8N1

⋮

- 115.2k 8E1 (factory setting)

⋮

- 115.2k 801

- confirm by pressing the „SET” button

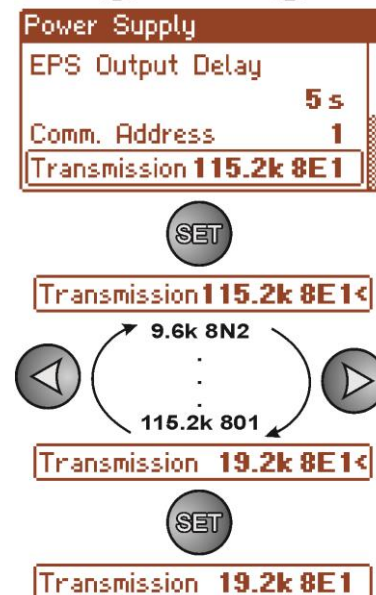

### 6.3 Control panel.



The menu is only available after entering the correct user's or service password.

The „control panel” menu enables configuration of the settings directly related to the user interface. It is possible to set the display language, date, time, intensity of the backlight and blinking light indicating failure.

Setting the correct date and time is important for keeping chronology of events stored in the internal memory. Setting the backlight mode and contrast guarantees the quality of the displayed messages.

Intensity of the LCD backlight can be set in the range from 0 to 100%, in 10% intervals.

The display features a function of constant or temporary backlight mode. In temporary mode, the screen will turn off if no buttons are pressed within 5 minute.



Fig. 23. „Control panel” screen.

Table 14. The description of the „Control panel” screen.

Position	Description
Language	Available languages
Date	Current time
Time	Current date
Backlight mode	<b>5 min</b> - backlight mode OFF if no buttons are pressed within 5 min <b>constant</b> - the backlight will not be turned off <b>0÷100%</b> - the intensity of the backlight
Contrast	<b>0÷ 100%</b> - the display contrast
Blinking light indicating failure	<b>YES</b> – blinking light indicating failure <b>NO</b> – constant light indicating failure

#### 6.3.1 Setting the display language.

One of the functions of the control panel menu is the possibility to select language. Display language can be set according to personal preference.



- use the „<” or „>” buttons to display the **Language** menu



- press the „SET” button, the prompt will appear at the end of the line



- use the „<” or „>” buttons to choose the display language



- confirm by pressing the „SET” button



### 6.3.2 Setting the date.

The „Date” menu in the „Control panel” menu enables setting the correct date, according to which error messages and operation history will be saved. Built-in real time clock does not take into account leap years and the changes resulting from the switch between summer and winter time. These changes should be taken into account when analyzing events recorded in the history.

- use the „<” or „>” buttons to display the **Date** menu

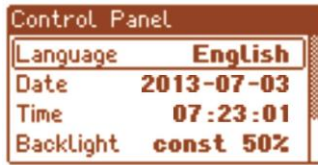

- press the „SET” button, the prompt will appear next to the year digits
- use the „<” or „>” buttons to set the year
- press the „SET” button, the prompt will appear next to the month position
- use the „<” or „>” buttons to set the current month
- press the „SET” button, the prompt will appear next to the day position
- use the „<” or „>” buttons to set the current day
- confirm by pressing the „SET” button

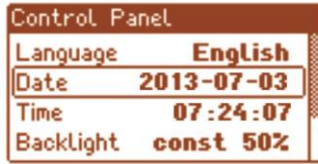

Date 2013<07-03



Date 2013-07<03



Date 2013-07-03<



Date 2013-07-03

### 6.3.3 Setting the time.

The „Time” menu in the „Control panel” menu enables setting the correct time, according to which error messages and operation history will be saved. Built-in real time clock does not take into account leap year and the changes resulting from the switch between summer and winter time. These changes should be taken into account when analyzing events recorded in the history.

- use the „<” or „>” buttons to display the **Time** menu

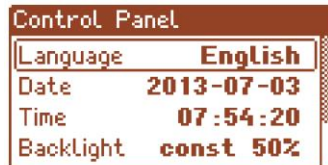

- press the „SET” button, the prompt will appear next to the hour digits
- use the „<” or „>” buttons to set the hour
- press the „SET” button, the prompt will appear next to the minute position
- use the „<” or „>” buttons to set the minutes
- press the „SET” button, the prompt will appear next to the seconds’ position
- use the „<” or „>” buttons to set the seconds
- confirm by pressing the „SET” button

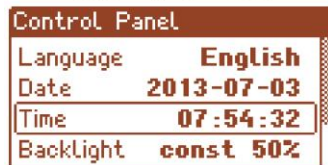

Time 07<54:35

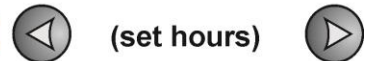

Time 07:54<35



Time 07:54:35<



Time 07:54:35



### 6.3.4 Setting the backlight mode.

The „Backlight” menu dims the display if no buttons are pressed within 5min and sets the intensity of the backlight.

- use the „<” or „>” buttons to display the **Backlight mode** menu
- press the „SET” button, the prompt will appear next to the **constant<** option
- use the „<” or „>” buttons to change the setting to **5 min**
- press the „SET” button, the prompt will appear at the end of the line
- use the „<” or „>” buttons to set the required brightness
- confirm by pressing the „SET” button



### 6.3.5 Contrast setting.

The „Contrast” menu in the „Control panel” enables setting the contrast of the display text.

- use the „<” or „>” buttons to display the **Contrast** menu
- press the „SET” button, the prompt will appear at the end of the line
- use the „<” or „>” buttons to set the contrast
- confirm by pressing the „SET” button

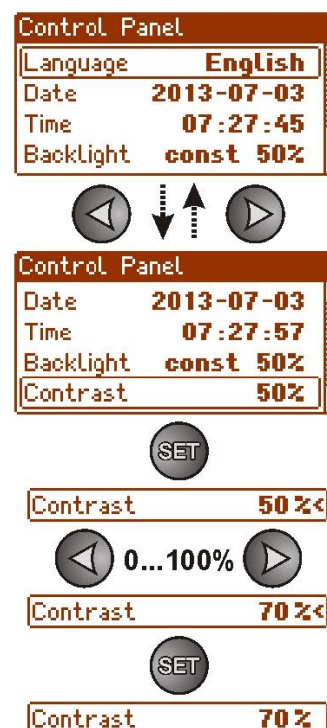

### 6.3.6 Blinking light indicating failure

The „Blinking light indicating failure” menu enables setting the backlight mode during failure indication. When on, the blinking light will indicate a failure.

- use the „<” or „>” buttons to display the Blinking **light indicating failure** menu



- press the „SET” button, the prompt will appear at the end of the line



- use the „<” or „>” buttons to select  
**YES** – blinking light indicating failure ON  
**NO** – blinking light indicating failure OFF



- confirm by pressing the „SET” button



### 7. Reserve power supply circuit.

The power supply is equipped with intelligent circuits: charging and battery control circuit, whose main task is to monitor the condition of the battery and its connections in the circuit.

If the power supply driver detects a malfunction in the battery circuit, appropriate signaling and change in the APS FLT technical output take place.

#### 7.1 Running the PSU from the battery.

The PSU has been equipped with two buttons on the PCB board which enable running or disconnecting the PSU during battery-assisted operation.

- **Running the PSU from the battery:** press the **START** button on the main board and hold for 1s.
- **Disconnecting the PSU from the battery:** press the **STOP** button on the main board and hold for 5s.

#### 7.2 Deep discharge battery protection UVP.

The PSU is equipped with the disconnection system and the discharged battery indication. If the voltage at the battery terminals drops below 20 V±0.2 V will turn on the beep sound and disconnect the battery in the 15 seconds.

Re-connecting the battery to the power supply occurs automatically upon the appearance of the ~230 V mains voltage.

##### Battery protection ON/OFF:

Enter the PSU settings from the LCD panel by pressing the „SET” button and select: „PSU -> Battery protection: ON/OFF” (see section. 6.2.3).



##### Caution.

Deactivating of the UVP function is not recommended since a deep discharge of the battery limits its capability of storing energy, lowers its capacity and shortens its durability.

#### 7.3 Battery test.

The PSU runs battery test every 5 minutes. During testing, the control unit of the PSU measures the electrical parameters according to the implemented measuring method.

A negative result occurs when the battery circuit continuity is interrupted or if the terminal voltage drops below 24 V.

The battery test can be activated manually (see section 6.2.2) from the menu of the power supply or by pressing the STOP button, for example to test the replaced batteries.

The PSU is protected against too frequent performing of the battery test, which could result in undercharging. The protection involves blocking the ability to perform test for 60 seconds from the last activation.

In this case, the LCD will display the "WAIT" message in the PSU Settings -> PSU -> Battery test menu.

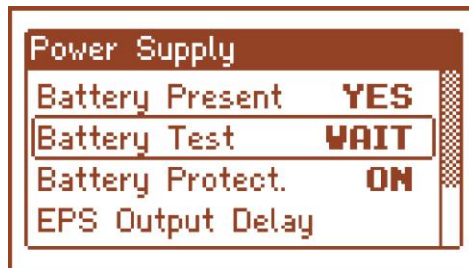

Fig. 24. Temporary lock of the battery test.

Temporary lock of the battery test can be disabled by putting the Z2 jumper between J1-J2 on the power supply board (Fig.2 [2]).



The battery test will also be automatically locked when the PSU is in the operating mode, in which the battery test is impossible. Such condition occurs, for example, during battery assisted operation or when the power supply is overloaded.

### 7.4 Standby time.

Battery-assisted operating depends on battery capacity, charging level and load current. To maintain an appropriate standby time, current drawn from the PSU in battery mode should be limited. Characteristics for a 2x17 Ah/12 V SLA:

Grade 1, 2 - standby time 12h

**Output current 1,4 A + 3 A battery charge**

Grade 3 - standby time 30h if the faults of the main power source are reported to the Alarm Receiving Centre - ARC (in accordance with 9.2 – EN 50131-1).

**Output current 0,56 A + 3 A battery charge**

- standby time 60h if the faults of the main power source are reported to the Alarm Receiving Centre - ARC (in accordance with 9.2 – EN 50131-1).

**Output current 0,28 A + 3 A battery charge**

### 7.5 Battery charging time.

The PSU has a battery circuit charged with direct current. The current selection is done with use of the I<sub>BAT</sub> jumpers. The table below shows how long does it take to charge a (fully discharged) battery up to min. 80% of its nominal capacity.

**Table 15. Battery charging time.**

2x17 Ah battery charging time up to the capacity of 0,8°C	Charging current [A]	Configuration of I <sub>BAT</sub> jumper
5h6m	3,0	J1= <input type="checkbox"/> , J2= <input type="checkbox"/> , J3= <input type="checkbox"/>
7h	2,2	J1= <input type="checkbox"/> , J2= <input type="checkbox"/> J3= <input checked="" type="checkbox"/>
10h12m	1,5	J1= <input type="checkbox"/> , J2= <input checked="" type="checkbox"/> J3= <input type="checkbox"/>
25h30m	0,6	J1= <input checked="" type="checkbox"/> , J2= <input type="checkbox"/> J3= <input type="checkbox"/>

### 7.6 Operation without a battery.

In case of an expected PSU operation without battery, select the appropriate configuration from the LCD panel (see section. 6.2.1).

**„Settings -> PSU -> Battery presence: YES/NO”**

In this mode, the automation system allows adjustments of PSU’s output voltage without indicating a failure connected with battery operation.



**CAUTION.** During operation without battery assistance the PSU does not perform any parameter control that monitors its proper operation. Therefore, this mode ought to be chosen thoughtfully.

### 8. Remote monitoring (options: Ethernet, RS485).

The PSU has been adjusted to operate in a system that requires a remote control of the parameters in a monitoring centre. Transmitting data concerning PSU status is possible due to an additional, external communication module responsible for communication in Ethernet or RS485 standard.

Different connection topologies, presented later in this chapter, are only a part of possible communication schemes. More examples can be found in the manuals dedicated to individual interfaces.



When installing optional features in the power supply unit, power supply current consumption, used for the calculation of standby time, should be taken into account (see section. 7.4).

#### 8.1 ETHERNET network communication.

Communication in the Ethernet network is possible due to the additional interfaces: Ethernet „INTE” and RS485-ETH „INTRE”, according to the IEEE802.3 standard.

The Ethernet „INTE” interface features full galvanic isolation and protection against surges. It should be mounted inside the enclosure of the PSU.

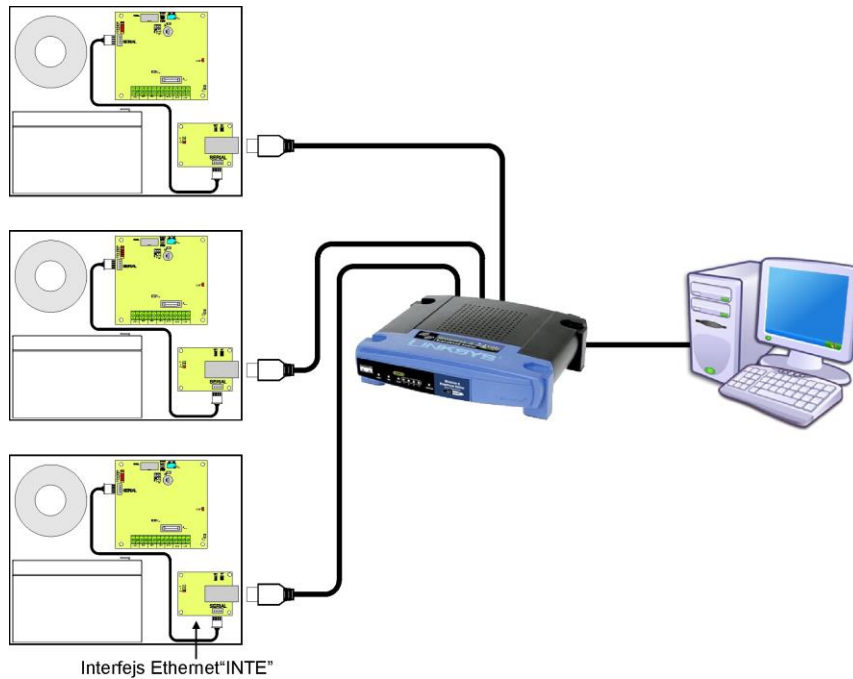

Fig. 25. Ethernet network communication using the Ethernet „INTE” interface.

The RS485-WiFi „INTRE” interface is a device used to convert signals between the RS485 bus and the Wi-Fi network. For proper operation, the unit requires an external power supply in the range of 10÷30 V DC e.g. drawn from a PSU of the PSBEN series. The unit is mounted in a hermetic enclosure protecting against adverse environmental conditions.

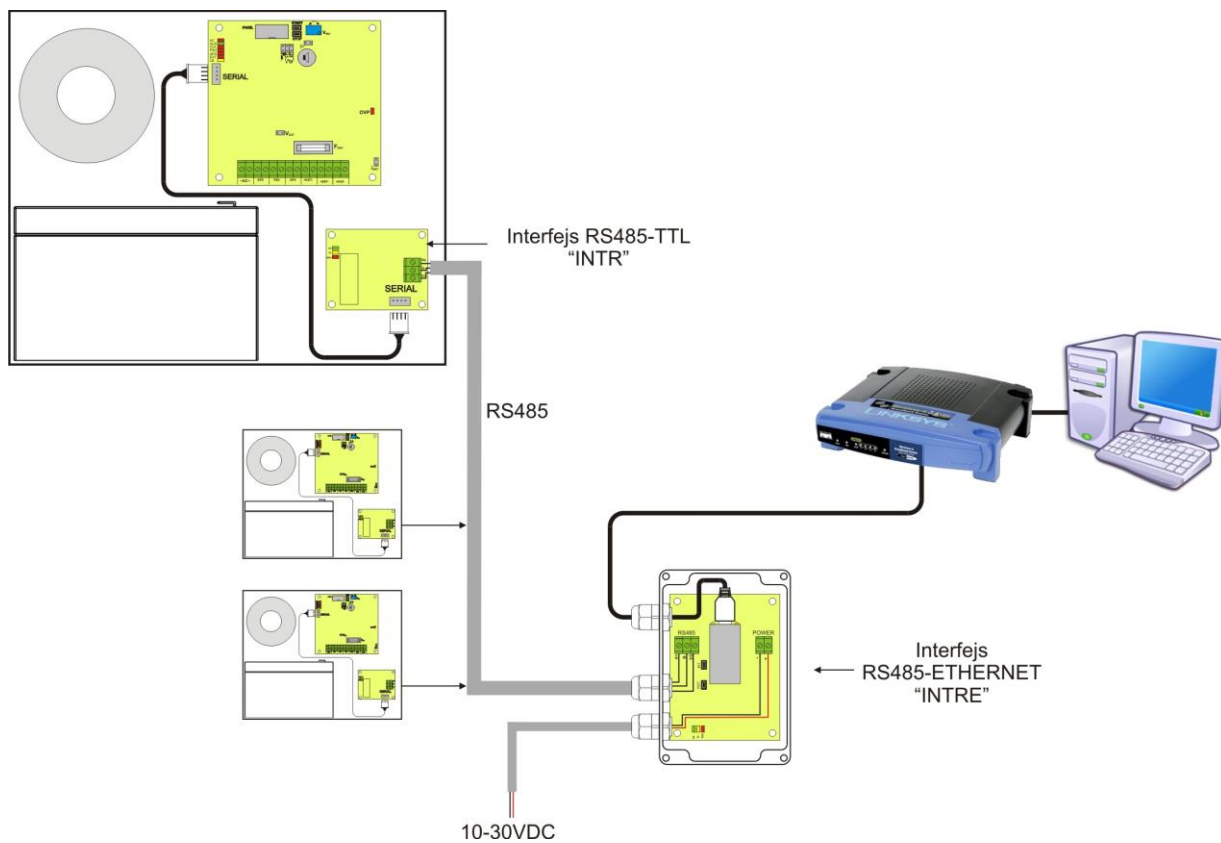

Fig. 26. Ethernet network communication using the RS485 „INTRE” interface.

## 8.2 „PowerSecurity” program.

The “Power Security” program is available at [www.pulsar.pl](http://www.pulsar.pl)  
Its detailed description can be found in the manual.

„Power Security” is a free computer program for viewing and analyzing the information sent from the PSU installation spots. The main panel is presented below.

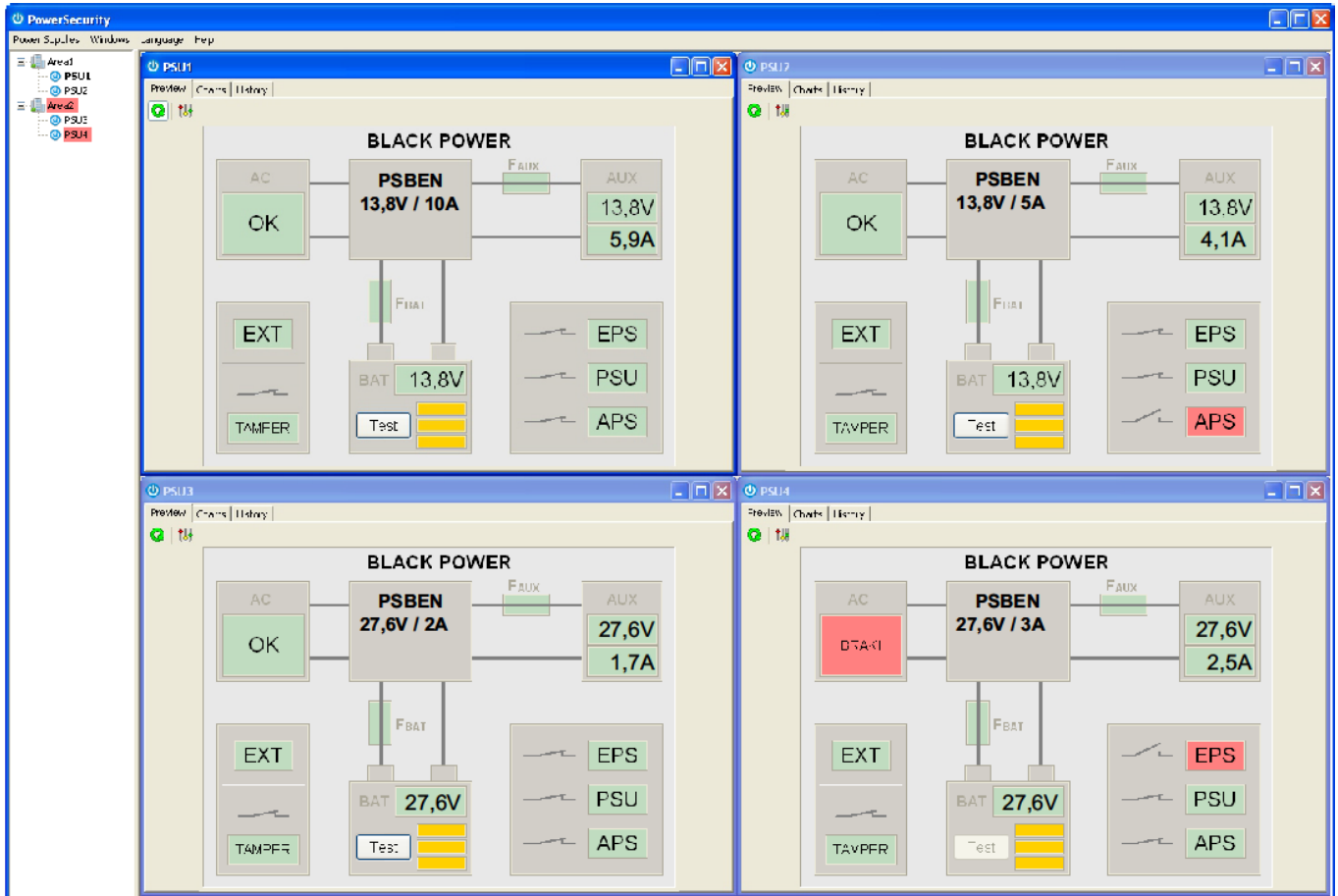

Fig. 27. „Power security” main panel.

It is possible to divide the main panel of the program into smaller areas, depending on the number of monitored power supplies.

The program is equipped with manager mode, which allows the grouping of power supplies for easier analysis and orientation.

The application enables both the visualization and analysis of the received data. Exceeding of the acceptable parameters is indicated by red illumination of the appropriate area or by blinking of the indicator light. Individual tabs allow monitoring the power supply parameters on the chart and failure memory along with the information about the status of technical outputs and electrical parameters.

## 9. Technical parameters.

Electrical parameters (Table 16).

Mechanical parameters (Table 17).

Safety of use (Table 18).

Table 16. Electrical parameters.

PSU type	A, protection class 1+3, II environmental class
Mains supply	~230 V; 50 Hz
Current consumption	1,1 A
PSU's power	155 W
Efficiency	83%
Output voltage	22 V± 27,6 V DC – buffer operation 20 V± 27,6 V DC – battery-assisted operation
Output current	<p>- for grades 1, 2:     I<sub>o</sub> = 1,4 A + 3 A battery charging</p> <p>- for grade 3:     I<sub>o</sub> = 0,56 A + 3 A battery charging - (connection with ARC required, compliant with 9.2 – EN 50131-1)     I<sub>o</sub> = 0,28 A + 3 A battery charging</p> <p>- for general use:     I<sub>o</sub> = 5 A + 0,6 A battery charging     I<sub>o</sub> = 4,1 A + 1,5 A battery charging     I<sub>o</sub> = 3,4 A + 2,2 A battery charging     I<sub>o</sub> = 2,6 A + 3 A battery charging</p>
Output voltage adjustment range	24 V± 29 V
Ripple voltage	160 mV p-p max.
Current consumption by the PSU systems during battery-assisted operation	I = 26 mA I = 17 mA – LCD panel backlight OFF
Battery charging current	0,6 A/1,5 A/2,2 A/3 A – I <sub>BAT</sub> jumper selectable
Low battery voltage indication	U <sub>bat</sub> < 23 V, during battery-assisted operation
Surge protection	varistors
Over voltage protection OVP	U > 31 V, disconnection of the output voltage, automatic return (AUX+ disconnection)
Short circuit protection SCP	Electronic – current limitation and / or F <sub>BAT</sub> fuse failure in the battery circuit (requires fuse replacement) Automatic return
Overload protection OLP	Program - equipment
Battery circuit protection SCP and reverse polarity connection	T 6,3 A- current limiting, F <sub>BAT</sub> fuse (failure requires fuse-element replacement)
Deep discharge battery protection UVP	U < 20,0 V (± 2%) – disconnection (-BAT) of the battery, adjustment from the LCD desktop's level
Indication of opening the cover of the power supply or detachment from the ground	Micro switch TAMPER
Technical outputs: - EPS FLT; output indicating AC power failure	- type – electronic, max 50mA/30 V DC, galvanic isolation 1500 V <sub>RMS</sub> - time lag, approx. 5s/140s/17m/2h 20m (+/-5%)
- APS FLT; output indicating battery failure	- type – electronic, max 50mA/30 V DC, galvanic isolation 1500 V <sub>RMS</sub>
- PSU FLT; output indicating PSU failure	- type – electronic, max 50mA/30 V DC, galvanic isolation 1500 V <sub>RMS</sub>
EXT IN technical input	Voltage 'on' – 10±30 V DC Voltage 'off' – 0±2 V DC Level of galvanic isolation: 1500 V <sub>RMS</sub>
Optical indication:	<p>- LEDs on the PSU's PCB, - LCD panel</p> <ul style="list-style-type: none"> <li>• readings of electrical parameters</li> <li>• failure indication</li> <li>• configuration of the PSU settings from the control panel</li> <li>• 3 levels of password protected access</li> <li>• operation memory of the PSU – 6144 values</li> <li>• failure memo - 2048 events</li> <li>• real time clock with battery backup</li> </ul>
Acoustic indication:	- piezoelectric indicator ~75 dB /0,3 m, switchable via jumper



<b>LCD screen battery</b>	3 V lithium battery, CR2032
<b>F<sub>BAT</sub> fuse</b> <b>F<sub>MAIN</sub> fuse</b>	T 6,3 A / 250 V T 6,3 A / 250 V
<b>Additional accessories</b> (not included)	- RS485 'INTR' interface: RS485 communication - Ethernet 'INTE' interface; Ethernet communication - RS485-Ethernet "INTRE" interface; RS485-Ethernet communication

**Table 17. Mechanical parameters.**

Dimensions	W=400, H=350, D+D <sub>1</sub> =92+8 [+/- 2mm] W <sub>1</sub> =405, H <sub>1</sub> =355 [+/- 2mm]
The dimensions of the battery compartment	380 x 165 x 85mm (WxHxD) max
Mounting	See Fig. 3
Net/gross weight	7,1/7,6 kg
Enclosure	Steel plate DC01 1mm, color RAL 9005 (black)
Closing	Cheese head screw x2 (at the front), lock assembly possible
Terminals	Supply: $\Phi 0,63 \pm 2,50$ (AWG 22-10) Outputs: $\Phi 0,51 \pm 2$ (AWG 24-12), BAT battery outputs: 6,3F-2,5, 30cm
Notes	The enclosure does not adjoin the assembly surface so that cables can be led. Convictional cooling.

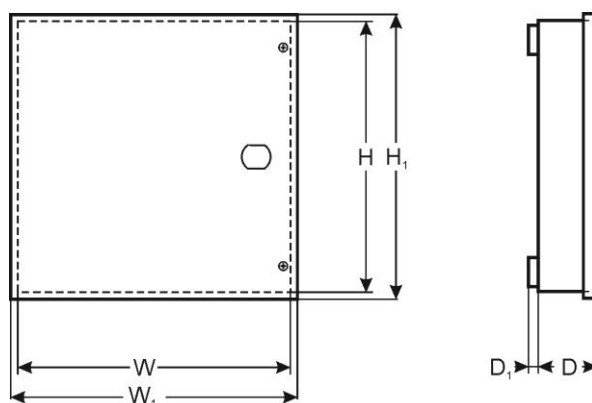
**Table 18. Safety of use.**

Protection class EN 60950-1:2007	I (first)
Protection grade EN 60529: 2002 (U)	IP20
Insulation electrical strength: - between input (network) circuit and the output circuits of the PSU - between input circuit and protection circuit - between output circuit and protection circuit	3000 V AC min. 1500 V AC min. 500 V AC min.
Insulation resistance: - between input circuit and output or protection circuit	100 M $\Omega$ , 500 V DC

### 10. Technical inspections and maintenance.

Technical inspections and maintenance can be performed after disconnecting the power supply from the power network. The PSU does not require any specific maintenance; however, its interior should be cleaned with compressed air if it is used in dusty conditions. In case of fuse replacement, use only compatible replacement parts.

Technical inspections should be carried out not less frequently than once per year. During the inspection, check the batteries and run the battery test.

4 weeks after installation, re-tighten all screw connections, see Fig. 2 [9].

#### 10.1 Battery replacement of the LCD panel.

Estimated operating time of battery type CR2032 is about six years. After this period, the battery will need to be replaced.

Battery replacement of the LCD panel should be done during mains operation or battery-assisted operation in order to avoid resetting the time settings.



**CAUTION!**

Removed batteries should be stored in a designated collection point. Do not reverse the polarity of the batteries. Do not use batteries of different types. Improper use of the battery may lead to explosion.



**WEEE LABEL**

According to the European Union WEEE Directive, waste electrical and electronic equipment should be disposed of separately from normal household waste. Waste electrical and electronic equipment must not be disposed of with normal household waste.



**CAUTION!** The power supply unit is adapted for cooperation with the sealed lead-acid batteries (SLA). After the operation period they must not be thrown but recycled according to the applicable law

**Pulsar sp. j.**

Siedlec 150, 32-744 Łapczyca, Poland  
Phone (+48) 14-610-19-40, Fax (+48) 14-610-19-50  
E-mail: [biuro@pulsar.pl](mailto:biuro@pulsar.pl), [sales@pulsar.pl](mailto:sales@pulsar.pl)  
http:// [www.pulsar.pl](http://www.pulsar.pl), [www.zasilacze.pl](http://www.zasilacze.pl)